

KOAH

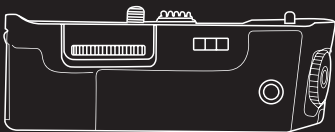

MANUAL

KO-DMW-BGG1

BATTERY GRIP

FOR PANASONIC G80/G85

WELCOME!

Dear Koah™ Customer,

Congratulations on your purchase of the Koah™ Battery Grip for Panasonic G80/G85! Follow these instructions carefully to use your battery grip to its full creative potential. Keep the manual in a safe place, and don't hesitate to reach out if there's any way we can help.

We hope you enjoy your new Koah™ Battery Grip!

Sincerely,

The Koah™ Team

KoahPRO.com



@KOAHPRO

For technical assistance and warranty service, please email us at **cs@koahpro.com**.

Power source	BLC12 battery
Power switch	Camera power switch
Temperature range	Up to 100°F
Humidity range	Up to 85%
Dimensions	5" (W) x 1.6" (H) x 2.5" (D)
Weight	10.1 oz (without battery)

Specifications and design are subject to change without notice.

This battery grip is compatible with the Panasonic G80/G85 and is designed for use with the BLC12 battery. It comes equipped with a vertical shutter release button for shooting in vertical orientation. The main dial allows you to operate it the same way as for horizontal shooting.

Panasonic® is a registered trademark of Panasonic Corporation. Koah™ is not affiliated with Panasonic® or any of its subsidiaries.

WARNINGS

- Only use this unit with the compatible devices and batteries stated in this manual.
- Keep the unit and batteries out of the reach of children.
- The battery level may not display properly if the batteries are inserted before the grip is attached to the camera.
- Because the unit has an electrical contact point with the camera, you should not insert the battery if the unit is not attached to the camera. This could cause damage. Remove the battery from the unit when attaching it to the camera, when detaching it from the camera, or when storing the unit for lengthy periods.
- Do not connect the USB cable to the camera when attaching the unit to the camera or when replacing the battery.
- Remove the batteries and stop using the unit if the product is broken and its insides become exposed or if an odor, heat, or smoke comes from the unit.

- When disposing of batteries, place tape over the battery contacts to avoid short circuiting. Always dispose of batteries according to local regulations.
- To avoid the risk of shock and voiding the warranty, do not try to disassemble or repair the unit.
- Do not use or store the unit in places that experience excessive vibrations, sand or dust, or electromagnetism. Do not allow the unit to come into contact with water, moisture, or fire. Keep the unit in a cool, dry area.
- Do not use or store the unit in extremely high temperatures or in places where it is exposed to direct sunlight, such as inside hot vehicles. Avoid high humidity environments.
- Do not subject the unit to rapid temperature changes. Doing so can cause condensation to form. For example, if you have been using the unit outdoors in cold temperatures, seal the unit in a plastic bag and remove all air from the bag before bringing it into the warm indoors, and wait until the temperature inside the bag equals the indoor temperature before removing it from the bag.
- Clean the unit with a dry cloth. Do not clean it with detergents or cleaning solvents.

- If you are using the unit with a lens mount adapter, you may not be able to attach a tripod to the lens adapter. Instead, attach the tripod to the unit.
- To avoid damage, do not attach the unit to a tripod using long screws. Only use screws that are no longer than 5.5 millimeters.
- Depending on the positioning of the camera's monitor, interference may occur when using the unit.

PARTS & FEATURES

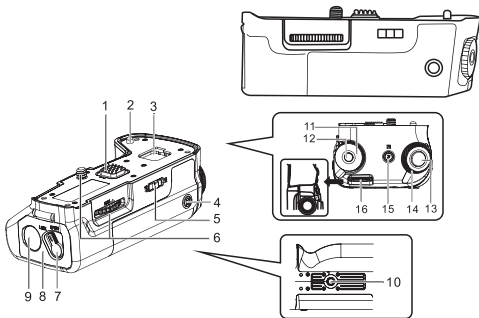

1. Terminal point
2. Camera attachment pins
3. Contact cap storage
4. AE/AF lock button
5. Vertical grip operation switch
6. Mounting screw
7. Battery door lock
8. Battery door
9. DC power supply cable hole
10. Tripod mount
11. Rear dial
12. FN1 button
13. Shutter release button
14. Front dial
15. Multi-function button
16. Strap attachment holder

INSTALLING AND REMOVING THE BATTERY GRIP

1. Remove the battery grip contact cap from the camera, as shown in the illustration below.
2. Remove the terminal protection cap from the battery grip, as shown. The camera contact cap can be stored in the grip's storage slot, as shown. To protect the electrical contacts, return the caps to their original positions after use.
NOTE: Keep the terminal cap in safe place while using the battery grip.

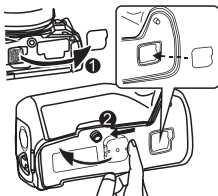

3. Align and insert the mounting screw, terminal point, and camera attachment pins, as shown in the illustration below.

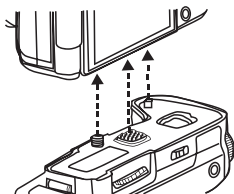

4. Turn the lock wheel in the direction of the arrow (counterclockwise) to twist the mounting screw, as shown in the illustration below. When using the grip, double-check that the screw is not loose.

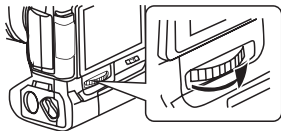

5. To remove the battery grip, first make sure the power switch is in the "off" position. Remove the battery before removing the battery grip from the camera. To remove the grip, turn the lock wheel in the opposite direction to loosen the mounting screw. Replace the terminal protection cap on the battery grip.

INSERTING THE BATTERY

1. First, charge the battery. The battery grip can be used when the battery is inserted in either the battery grip or the camera. Make sure that the camera is turned off before inserting the battery.
2. Open the battery door by turning the release lever toward "open," as shown in the illustration below.

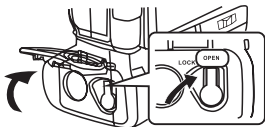

3. Carefully insert the battery all the way until you hear a locking sound, and confirm that the lever is hooked to the battery, as shown in the illustration below.

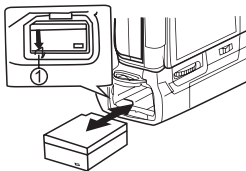

4. Close and secure the battery door by turning the release lever toward “lock,” as shown in the illustration below.

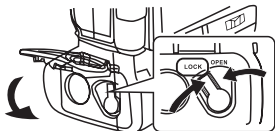

NOTE:

- Remove the battery after use to avoid draining the battery.
- The battery and battery grip will become warm or hot during use and when charging.
- You can use two batteries interchangeably in the camera and battery grip. The grip will automatically switch to the other battery when one of the batteries is depleted.
- Place the primary battery in the camera. Do not remove it when the battery in the battery grip is in use. Doing so will turn off the camera power.

SHOOTING WITH THE BATTERY GRIP

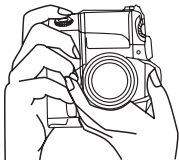
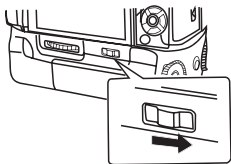

- When shooting vertically, turn the vertical grip operation switch to the “on” position, as shown in the illustration above.
- When shooting horizontally, turn the vertical grip operation switch to the “off” position.
- You can check the battery power level on the camera’s monitor.

TROUBLESHOOTING

Issue	Solution
<p>Camera does not work even though the battery grip is attached to the camera, the batteries are inserted in the grip, and the camera power is turned on.</p>	<p>Ensure that the battery grip attachment screw is tightened securely.</p>
	<p>Ensure that the batteries are charged.</p>
	<p>Remove the batteries from the battery tray and reinsert them.</p>
	<p>Turn the camera power off, remove the batteries, and reattach the battery grip to the camera.</p>

The shutter button or other buttons are not working.	Ensure that the battery grip's on/off switch is not set to "off."
	Remove the batteries from the battery tray and reinsert them.
	Turn the camera power off, remove the batteries, and reattach the battery grip to the camera.
The message "Lithium Battery Only" is displayed even though a genuine Panasonic battery is being used.	Remove the batteries from the battery tray and reinsert them.
	Turn the camera power off, remove the batteries, and reattach the battery grip to the camera.

KOAH